

# S SANEL® AUTO ELECTRONIC

**ELECTRONIC PRODUCTS FOR VEHICLE INDUSTRY**  
**ARAÇLAR İÇİN ELEKTRONİK ÜRÜNLER**

[www.sanel.com.tr](http://www.sanel.com.tr)

**S SANEL®**  
**AUTO ELECTRONIC**

SANEL SANAYİ ELEKTRONİĞİ  
İMALAT VE TİCARET LTD. ŞTİ.

Gülsuyu Mah. Çiçek Sk. No: 5  
Maltepe, İstanbul 34848, TURKEY  
Tel : +90 216 427 26 50  
Fax : +90 216 427 26 54  
e-mail: sanel@sanel.com.tr

<http://www.sanel.com.tr>





**SANEL** was founded in 1980 to produce electronic parts for Automotive Industry.

First productions were electronic regulators, and electronic flashers.

Over the years, SANEL has developed its product range by 350 pcs, SANEL had an expertise in design and development, and we had a capacity of producing 2 million pcs / year in our 4000 m<sup>2</sup> closed area factory.

Today, SANEL is one of the leading Turkish electronic manufacturer for local and international automotive industries.

165 qualified employees are well trained for Quality Assurance and Zero Defect. SANEL' s production range can maintain all electronic demands for cars, buses, trucks, LCV's tractors boats and motorcycles. SANEL R&D department is able to produce custom design products.

**SANEL**, 1980 yılında otomotiv fabrikalarına elektronik parça üretimi yapmak için kurulmuştur. Geçen yıllar boyunca ürettiğimiz çeşit sayısı 350'ye ulaşırken, kazandığımız tecrübe, teknolojik gelişmelerle, 4000 m<sup>2</sup> lik alanı olan fabrikamızda yıllık üretimimiz 2 milyon adete yükselmiştir.

Bugün Türkiye'nin önde gelen elektronik üreticilerinden biri olarak, otomotiv fabrikaları ve yedek parça piyasasına hizmet veren SANEL, ürünlerinin önemli bir kısmını da ihraç etmektedir.

Ürün gamımız, her marka binek arabaların, otobüslerin, kamyonların, hafif ticari araçların, traktörlerin ve motosikletlerin bütün elektronik ihtiyaçlarını karşılayabilmektedir.

Ar-Ge departmanımız müşteriye özel üretim çalışmaları da yapabilmektedir.



### Quality Assurance

SANEL certified by ISO 9001:2000 Quality Certificate by RWTÜV and EMC complied.

165 qualified employees are well trained for Quality Assurance and Zero Defect production.

### Manufacturing and Supplying

Our production is mainly for automotive factories e.g. Ford Otosan, Mercedes, BMC, Fiat Tractor T.T.F., Massey Ferguson Uzel, Ford Tractor, Magirus Otokar, Iveco Otoyol, Peugeot Karsan, Isuzu Anadolu, Mitsubishi Temsa, M.A.N. , Beldeyama, Askam. SANEL's Aftermarket sales are run by 20 representatives all around Turkey.

### Export Experience

SANEL also exports to European countries such as Belgium, Holland, Greece, Spain, France, England, Portugal, North African and Asian countries such as Iran, Egypt, Syria, Libya, Morocco, Israel and the USA.

### Cost Optimization

We offer you "expertise on cost optimization" with Competitive Prices, Quick Delivery and International Quality and Performance.

### Kalite Güvencesi

RWTÜV tarafından ISO 9001:2000 sertifikası ile belgelendirilen SANEL, EMC uyumlu ürünler üretmektedir.

165 kalifiye çalışmamız Sıfır Hata Programı ve Kalite Güvence Sistemi esaslarına göre üretim yapmaktadır.

### Üretim ve Tedarik

Üretimimiz genellikle Otomotiv Fabrikalarına yöneliktir, mesela; Ford Otosan, Mercedes, BMC, Fiat Traktör, Massey Ferguson Uzel, T.T.F., Ford Traktor, Magirus Otokar, IVECO Otoyol, Peugeot Karsan, Isuzu Anadolu, Mitsubishi Temsa, M.A.N., Beldeyama, Aksam' dır.

Yedek Parça satışlarımız, yurt sathına dağılmış 20 seçkin bayimiz tarafından gerçekleştirilmektedir.

### İhracat Tecrübesi

SANEL ürünleri genellikle Avrupa ülkelerine ihraç edilmektedir. Mesela; Belçika, Yunanistan, Hollanda, İspanya, Fransa, İngiltere, İran, Mısır, Suriye, Libya, Fas, İsrail ve A.B.D. gibi,

### Maliyet Optimizasyonu

İlkemiz; sizlere, uygun fiyatlar, hızlı tedarik ve uluslararası kalite ve performansımızla en iyi hizmeti sunmaktadır.





**FLASHERS / FLAŞER****6-12**

Kablolu Flaşer - Tır & Traktör Flaşeri - El Fren Flaşerleri - Japon Araç Flaşeri - Mekanik Flaşer - Elektromekanik Flaşer - Motosiklet Flaşeri - Towbar Modülü  
Flashers With Cable - Flashers For TIR & Tractors - Hand Brake Flasher - Japanese Flashers - Mechanic Flasher  
Electromechanic Flashers - Motorcycle Flashers - Towbar Modules

**RELAYS / RÖLE****13-17**

Mini Röle - Sigortalı Röle - Mikro Röle - Güç Rölesi - Far Rölesi - Yankılı & Titreyen Röle  
Mini Relays - Relay With Fuse - Micro Relay - Power Relays - Head Lamp Double Relays - Echo & Vibration Horn Relays

**TIMERS / ZAMAN RÖLESİ****18-23**

İç Aydınlatma Zaman Rölesi - Far Yıkama Rölesi - Buji Kızdırma Rölesi - Sis Lambası Rölesi - Açık Kapı İkaz Zaman Rölesi - Flip Flop Kapı Açma Kapama Rölesi - Açık Kapı İkaz Zaman Rölesi - Kapı Emniyet Devresi - Fren Balatası Devresi - İkaz Ünitesi - Marş Koruma Rölesi - Çok Amaçlı Zaman Röleleri  
Interior Light Timer - Headlamp Washer Timer - Pre And Post Heating Relay - Fog Lamp Relay - Open Door Warning Timer  
Flip Flop Door Open & Close Switch - Flip Flop Open Door Warning Timer - Door Security Circuit - Brake Disc Circuit - Warning Units  
Start Repeat Locking - Multi Purpose Timer Relays

**WIPER TIMERS / SİLECEK ZAMAN RÖLESİ****24-25****LEVEL SENSORS / SEVİYE İKAZ RÖLESİ****26-27**

Su Seviye İkaz Rölesi - Yakıt Filtresi Su Dedektörü / Water Level Warning Relay - Water Detector In Fuel Filter

**RECTIFIERS / DİYOT ÜNİTELERİ****28-29****REGULATORS / REGÜLATÖR****30-31**

Alternatör Regülatörü - Magneto Regülatörü - Aşırı Voltaj Koruma  
Alternator Generator Regulators - Flywheel Magnet Regulator - Over Voltage Protection

**BUZZERS & SIRENS / BUZZER VE SESLİ İKAZ****32-33**

Buzzer - Geri Vites İkaz Kornası - Sirenler / Buzzers - Back Horns - Sirens

**24V - 12V DC / DC CONVERTERS / KONVERTÖR****34-35**

Lineer Konvertör - Switchmod Konvertör / Linear Converters - Switchmode Converters

**LIGHTING FIXTURES / AYDINLATMA MODÜLÜ****36-39**

Floresan Aydınlatma Gömme Tip Montaj - Floresan Aydınlatma Yüzey Tip Montaj - Sofit Lamba - Ampullü Tavan Lambası  
Recessed Mount Fluorescent Fittings - Surface Mount Fluorescent Fittings - Festoon Lamps - Bulb Lamps

**LED LIGHTS / LED LAMBA****40-42**

Led Lambalar - Piktogram - Yön Gösterge Panosu / Led Lamps - Pictogram - Destination Sign

**ELECTRONIC FLUORESCENT INVERTERS / ELEKTRONİK FLORESAN BALAST****43****DIGITAL BUS CLOCK / DİJİTAL OTOBÜS SAATİ****44-45**

Gömme Tip Montaj - Yüzey Tip Montaj / Recessed Mount - Surface Mount

**BUS SIGN UNITS / OTOBÜS İŞARET ÜNİTESİ****46-47**

Gömme Tip Montaj - Yüzey Tip Montaj / Recessed Mount - Surface Mount

**STOP BUTTONS / STOP BUTONLARI****48****ACCESSORIES / AKSESUARLAR****49**

Anahtarlar - Elektronik Am/Fm Anten - Ara Bıçak Sigorta Yuvası / Switches - Electronic Am/Fm Antenna - Blade Fuse Holder

**MOTORCYCLE PARTS / MOTOSİKLET PARÇALARI****50**

Stop Anahtarı - Regülatör - Komütatör - Özel Tasarım / Stop Switch - Regulator - Commutators - Custom Design

**PCB TYPE FUSE & RELAY PANELS / SİGORTA & RÖLE PANOLARI****51****CABLE HARNESS / KABLO DEMETLEME****52**







# PRODUCT CODE INDEX / ÜRÜN LİSTESİ

Code/Kod	Page/Sayfa	Code/Kod	Page/Sayfa	Code/Kod	Page/Sayfa
ADZ9	50	SB895	32	SEA412	49
AVK012	31	SB896	32	SFA1208	36
AVK024	31	SBA12B12	41	SFA1216	36
BFA935	50	SBA12B20	41	SFA1218	36
BFA936	50	SBA12R12	41	SFA2408	36
EFB1208	43	SBA12R20	41	SFA2416	36
EFB1208U	43	SBA12R3	40	SFA2418	36
EFB1208UD	43	SBA12W12	41	SFB209	20
EFB1213	43	SBA12W20	41	SFB210	20
EFB1213U	43	SBA12W3	41	SFF241	19
EFB1213UD	43	SBA12Y3	40	SFL984	39
EFB1218	43	SBA24B12	41	SFL985	39
EFB1218U	43	SBA24B20	41	SGH520	18
EFB1218UD	43	SBA24B3	41	SHF292	12
EFB1221	43	SBA24B6	41	SHS012	21
EFB1221U	43	SBA24R12	41	SKE211	20
EFB1221UD	43	SBA24R20	41	SKF242	20
EFB1228	43	SBA24R3	40	SKR120	15
EFB1228U	43	SBA24R6	41	SKZ240	19
EFB1228UD	43	SBA24RB20	41	SLG484	18
EFB1235	43	SBA24W12	41	SLG485	18
EFB1235U	43	SBA24W20	41	SLI060	21
EFB1235UD	43	SBA24W3	41	SLR012	16
EFB1236	43	SBA24W6	41	SLR024	16
EFB1236U	43	SBA24Y3	40	SMC10	35
EFB1236UD	43	SBH834	33	SMC101	35
EFB2408	43	SC2405	34	SMC15	35
EFB2408U	43	SC2410	34	SMC15M	35
EFB2408UD	43	SC2415	34	SMF283	7
EFB2413	43	SC2420	34	SMF88	12
EFB2413U	43	SC2475	34	SMF92	12
EFB2413UD	43	SCA10	35	SMK141	21
EFB2418	43	SCA15	35	SMK142	21
EFB2418U	43	SCM2405	34	SMS939	33
EFB2418UD	43	SDH001	33	SMS940	33
EFB2421	43	SDI760	46	SMS960	33
EFB2421U	43	SDI761	46	SPB2408FAA	37
EFB2421UD	43	SDS308	45	SPB2413FAA	37
EFB2428	43	SDS309	45	SPB2416FAA	37
EFB2428U	43	SDS310	45	SPB2421FAA	38
EFB2428UD	43	SDS311	45	SPB2421FAA	38
EFB2435	43	SDS312	44	SPB2426FAA	37
EFB2435U	43	SDS313	44	SPB2428FAA	38
EFB2435UD	43	SDS314	44	SPB2428FAB	38
EFB2436	43	SDS315	44	SPB2430LAA	42
EFB2436U	43	SdT900	29	SPB2435FAA	38
EFB2436UD	43	SdT902	28	SPF287	9
FYR90	18	SdT903	28	SPF487	9
LLP941	26	SdT905	28	SPG124	42
LLR937	27	SdT906	28	SPG126	42
LLR938	27	SdT907	28	SR114A	31
LLS931	26	SdT908	28	SR1206	16
LLS932	26	SdT909	28	SR1207	16
LLS933	26	SdT910	28	SR1243A	13
LLS934	26	SdT911	29	SR1243B	13
LLS963	26	SdT916	29	SR1244	15
MAZ293	11	SdT917	29	SR1245	16
MR98	30	SdT918	29	SR1245U	16
SAS944	25	SdT921	29	SR1251A	13
SB888	32	SdT925	29	SR1251B	13
Sb890	32	SdT926	29	SR1252A	14



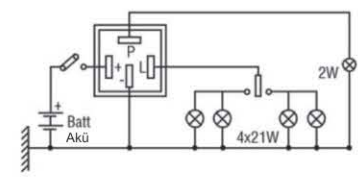

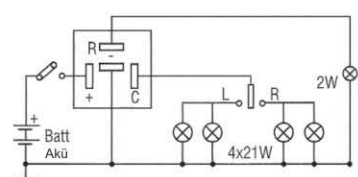

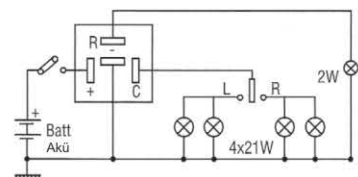

<b>Code/Kod</b>	<b>Page/Sayfa</b>	<b>Code/Kod</b>	<b>Page/Sayfa</b>	<b>Code/Kod</b>	<b>Page/Sayfa</b>
SR1252B	14	SSB868	48	SSL12B18	40
SR1255	15	SSB869	48	SSL12B24	40
SR1256A	13	SSB870	48	SSL12R18	40
SR1256B	13	SSB871	48	SSL12R24	40
SR128A	31	SSF012	8	SSL12W18	40
SR2406	16	SSF024	8	SSL12W24	40
SR2407	16	SSF276	7	SSL12Y18	40
SR2443A	13	SSF277	7	SSL12Y24	40
SR2443B	13	SSF281	6	SSL24B18	40
SR2444	15	SSF282	9	SSL24B24	40
SR2445	16	SSF283	7	SSL24R18	40
SR2451A	13	SSF284	7	SSL24R24	40
SR2451B	13	SSF285	7	SSL24W18	40
SR2452A	14	SSF286	6	SSL24W24	40
SR2452B	14	SSF287	9	SSL24Y18	40
SR2453	15	SSF288	8	SSL24Y24	40
SR2455	15	SSF290	8	SSS912	19
SR9312	30	SSF291	7	SSS913	19
SR9312D	30	SSF294	6	SSS924	19
SR9324	30	SSF295	6	SSW100	50
SR9912	30	SSF296	8	ST212	22
SR9924	30	SSF297	8	ST213	22
SRD1243A	13	SSF383	9	ST245	22
SRD1243B	13	SSF384	9	ST246	23
SRD1251A	14	SSF385	10	STI770	47
SRD1251B	14	SSF386	10	STI771	47
SRD1252A	14	SSF387	10	STI772	47
SRD1252B	14	SSF388	10	STI773	47
SRD2443A	13	SSF389	10	STI774	46
SRD2443B	13	SSF450	11	STI775	46
SRD2451A	14	SSF451	11	STL701	39
SRD2451B	14	SSF452	11	STL702	39
SRD2452A	14	SSF453	11	STL703	39
SRD2452B	14	SSF481	6	STL704	39
SRM001	12	SSF482	9	STR107	17
SRM002	12	SSF483	7	STR108	17
SRM004	12	SSF485	7	STS802	45
SRR1243A	13	SSF486	6	SUF116	10
SRR1243B	13	SSF488	8	SUF117	10
SRR1251A	14	SSF490	8	SUF118	10
SRR1251B	14	SSF494	6	SVI041	21
SRR1252A	14	SSF495	6	SW00	49
SRR1252B	14	SSF496	8	SW01	49
SRR2443A	13	SSF550	11	SW02	49
SRR2443B	13	SSF783	9	SW04	49
SRR2451A	14	SSF883	9	SYG720	42
SRR2451B	14	SSG884	24	SYR112	17
SRR2452A	14	SSG885	24	SYR124	17
SRR2452B	14	SSG886	25	T12M20	23
SRR685	31	SSG989	25	T12S3	23
SRS943	24	SSG991	24	T12S5	23
SRT945	22	SSG992	24	T12S90	23
SRT946	22	SSG993	24	T24M2	23
SRT948	22	SSG994	25	T24S0-5	23
SRT949	22	SSG995	25	T24S30	23
SRT951	22	SSG996	25	TOY300	11
SSG990	25	SSI750	46	YSD201	27
SSB860	48	SSI751	46	YSD223	27
SSB862	48	SSI752	47	YSD224	27
SSB863	48	SSI753	47		
SSB867	48	SSK003	49		



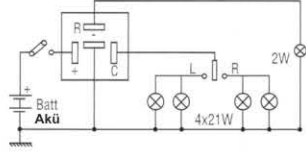



Araçlar Vehicles		Kod Code	Volt	Watt	Terminal	İkaz Lambası Faillamp	Braket Bracket	Bağlantı Şeması Connections
	Iveco 4800839	SSF294	12	2(4)x21	4	<input type="checkbox"/>	<input type="checkbox"/>	
		SSF494	12	2(4)x21	4	<input checked="" type="checkbox"/>	<input type="checkbox"/>	
		SSF295	24	2(4)x21	4	<input type="checkbox"/>	<input type="checkbox"/>	
		SSF495	24	2(4)x21	4	<input checked="" type="checkbox"/>	<input type="checkbox"/>	
	Renault 5	SSF281	12	2(4)x21	4	<input type="checkbox"/>	<input checked="" type="checkbox"/>	
		SSF481	12	2(4)x21	4	<input checked="" type="checkbox"/>	<input checked="" type="checkbox"/>	
	Renault Peugeot Fiat Seat	SSF286	12	2(4)x21	4	<input type="checkbox"/>	<input type="checkbox"/>	
		SSF486	12	2(4)x21	4	<input checked="" type="checkbox"/>	<input type="checkbox"/>	

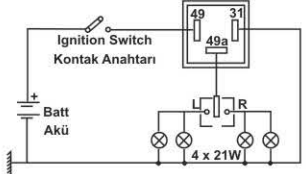

Araçlar Vehicles	Kod Code	Volt	Watt	Terminal	İkaz Lambası Faillamp	Braket Bracket	Bağlantı Şeması Connections
  <p>Renault Peugeot Fiat Seat</p>	SSF276	12	2(4)x21	4	<input type="checkbox"/>	<input type="checkbox"/>	
	SSF277	12	2(4)x21	4	<input checked="" type="checkbox"/>	<input type="checkbox"/>	

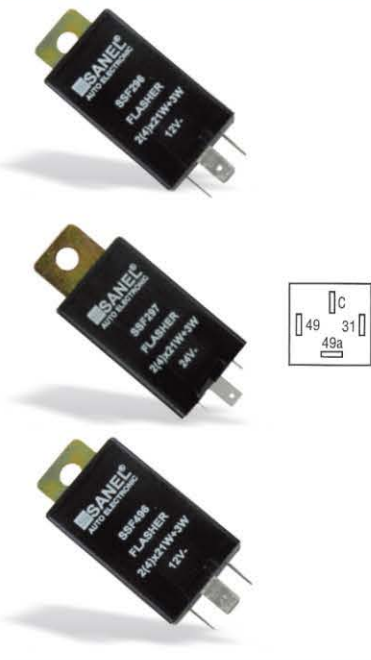
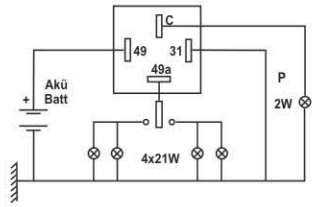
  <p>Audi BMW Ford Opel Mercedes Volvo Fiat Citroen Peugeot Magirus VW</p> 	SMF283	12	2(4)x21	3	<input type="checkbox"/>	<input type="checkbox"/>	
	SSF283	12	2(4)x21	3	<input type="checkbox"/>	<input type="checkbox"/>	
	SSF483	12	2(4)x21	3	<input checked="" type="checkbox"/>	<input type="checkbox"/>	
	SSF284	12	2(4)x21	3	<input type="checkbox"/>	Klips clip	
	SSF285	24	2(4)x21	3	<input type="checkbox"/>	<input checked="" type="checkbox"/>	
	SSF485	24	2(4)x21	3	<input checked="" type="checkbox"/>	<input type="checkbox"/>	
	SSF291	24	3(6)x21	3	<input checked="" type="checkbox"/>	<input type="checkbox"/>	

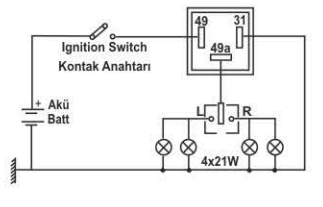

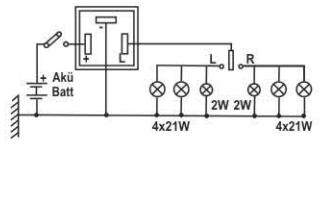

	Araçlar Vehicles	Kod Code	Volt	Watt	Terminal	İkaz Lambası Faillamp	Braket Bracket	Bağlantı Şeması Connections
	BMW Mercedes Saab Volvo Audi VW	SSF296	12	2(4)x21	4	<input type="checkbox"/>	<input checked="" type="checkbox"/>	
		SSF297	24	2(4)x21	4	<input type="checkbox"/>	<input checked="" type="checkbox"/>	
		SSF496	12	2(4)x21	4	<input checked="" type="checkbox"/>	<input checked="" type="checkbox"/>	
	Audi BMW Opel Skoda VW Ford Volvo	SSF290	12	2(4)x21	3	<input type="checkbox"/>	<input type="checkbox"/>	
		SSF490	12	2(4)x21	3	<input checked="" type="checkbox"/>	<input type="checkbox"/>	
	Fiat	SSF288	12	2(4)x21	3	<input type="checkbox"/>	<input type="checkbox"/>	
		SSF488	12	2(4)x21	3	<input checked="" type="checkbox"/>	<input type="checkbox"/>	

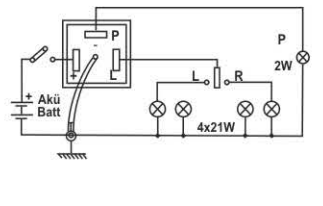
## Flashers With Cable / Kablolu Flaşer



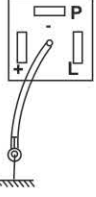

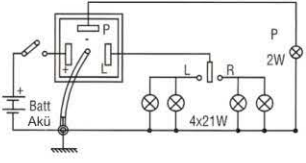
	Replace Thermal Flasher	SSF012	12	10+110	3+1	<input type="checkbox"/>	<input type="checkbox"/>	
		SSF024	24	10+110	3+1	<input type="checkbox"/>	<input type="checkbox"/>	







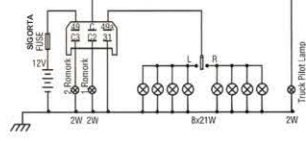

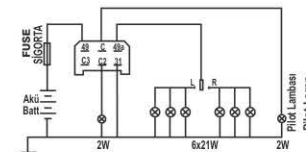
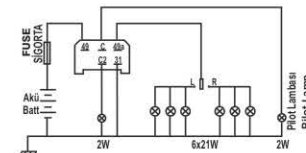
Araçlar Vehicles	Kod Code	Volt	Watt	Terminal	İkaz Lambası Faillamp	Braket Bracket	Bağlantı Şeması Connections
   	SSF287	12	2(4)x21	3+1	□	□	
	SPF287	12	2(4)x21	3+1	■	■	
	SPF487	12	2(4)x21	3+1	■	□	
	SSF282	24	2(4)x21	3+1	□	■	
	SSF482	24	2(4)x21	3+1	■	■	

Replace Thermal Flasher

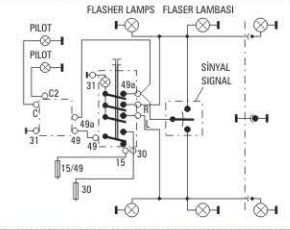

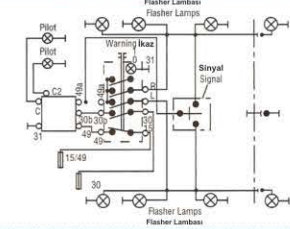

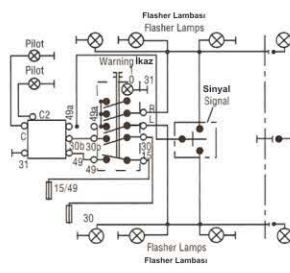
## Flashers For TIR & Tractors / TIR ve Traktör Flaşerleri

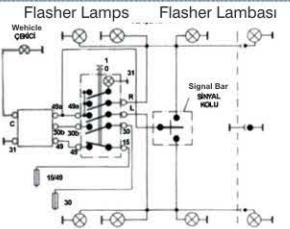
<p>For 2 trailers 2 römork için</p>  	American type 60 cycles for warning	SSF783	12	(2+1+1)x21W (8x21W)	6	■	■	
<p>Sealing is optional IP66 Sızdırmazlık opsiyoneldir</p>	Fiat Massey Ferguson Iveco Steyr Volvo	SSF883	12	(2+1+1)x21W (8x21W)	6	■	■	
<p>For 1 trailer 1 römork için</p>  		SSF383	12	(2+1)x21W (6x21W)	6	■	■	
<p>Sealing is optional IP66 Sızdırmazlık opsiyoneldir</p>		SSF384	24	(2+1)x21W (6x21W)	5	■	■	



	Araçlar Vehicles	Kod Code	Volt	Watt	Terminal	İkaz Lambası Faillamp	Braket Bracket	Bağlantı Şeması Connections
	Mercedes M.A.N. Iveco Renault Volvo Scania	SSF385	24	(2+1)x21W (6x21W)	6	■	■	
	Mercedes M.A.N. Iveco Volvo	SSF386	12 24	1...8x18/21W	6	□	■	
	Volvo Magirus Mercedes	SSF388	12	(3+1)x21W (8x21W)	6	■	■	
		SSF387	24	(3+1)x21W (8x21W)	6	■	■	
		SSF389	24	(3+1)x21W (8x21W)	5	■	■	

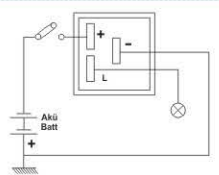

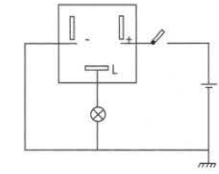
## Hand Brake Flashers / El Freni Flaşeri

		SUF116	12	1...10W	3	□	□		
		Fiat Tractor Iveco	SUF117	12	1...10W	3	□	□	
		SUF118	24	1...10W	3	□	□		

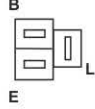
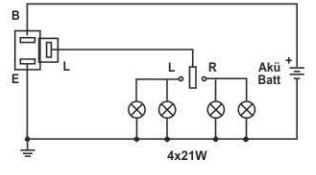
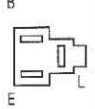
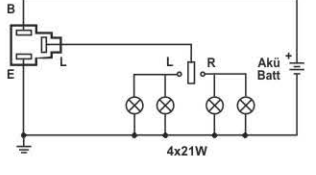



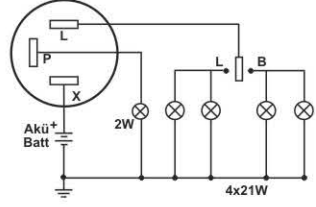

		Araçlar Vehicles	Kod Code	Volt	Watt	Terminal	İkaz Lambası Faillamp	Braket Bracket	Bağlantı Şeması Connections
		Toyota	TOY300	12	2(4)x21W	3	■	□	
		Mazda	MAZ293	12	2(4)x21W	3	■	□	

## Mechanic Flasher / Mekanik Flaşer



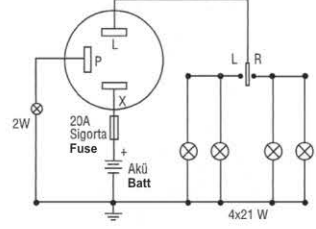

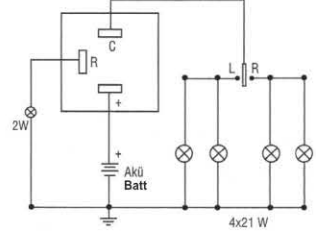
			SSF550	12	2(4)x21W	3	□	□	
--	--	--	--------	----	----------	---	---	---	--

## Electromechanic Flashers / Elektromekanik Flaşer

			SSF450	12	2(4)x21W	3	□	□	
			SSF451	24	2(4)x21W	3	□	□	
			SSF452	12	47W 180W max	3	□	■	
			SSF453	24	47W 180W max	3	□	■	

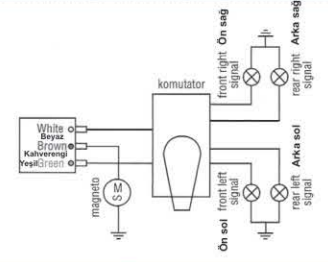

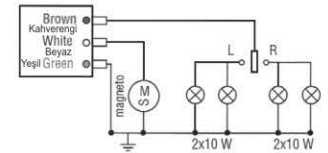

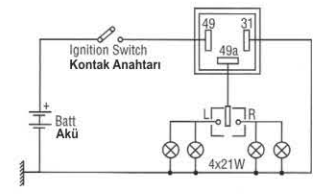

# Motorcycle Flashers / Motosiklet Flaşeri

	Araçlar Vehicles	Kod Code	Volt	Watt	Terminal	İkaz Lambası Faillamp	Braket Bracket	Bağlantı Şeması Connections
	Mobylette	SMF88	12 AC	2x21W	3	□	■	
	Mobylette	SMF92	12 AC	2x10W	3	□	■	
	Honda	SHF292	12	2x10W	3	■	■	

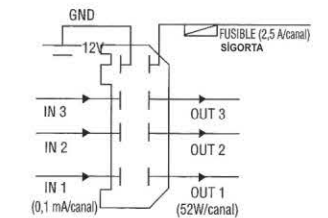
# Towbar Modules / Towbar Modülü

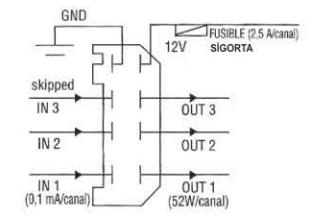
Data communication between vehicle and trailer / Araç ile römork arasındaki data iletişimini sağlar

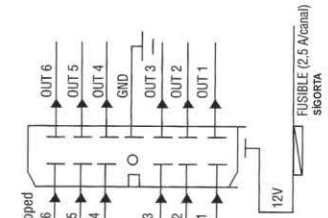

	SRM001	12	3x52W	8	■	■	
	SRM002	12	3x52W	8	■	■	
	SRM004	12	6x52W	14	■	■	

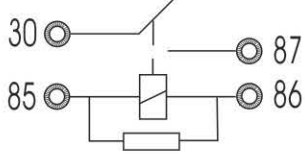
## Mini Relays / Mini Röle

	Kod Code	Tarif Description	Volt	Amp.	Terminal	Braket Bracket	Bağlantı Şeması Connections
	SR1243A	Normal Açık Normally Open 1 Form A	12	30A	4	■	
	SR1243B					□	
	SR2443A		24	20A	4	■	
	SR2443B					□	
	SRD1243A	Diyotlu 1 Form A with Diode	12	30A	4	■	
	SRD1243B					□	
	SRD2443A		24	20A	4	■	
	SRD2443B					□	
	SRR1243A	Direnci 1 Form A with Resistance	12	30A	4	■	
	SRR1243B					□	
	SRR2443A		24	20A	4	■	
	SRR2443B					□	
	SR1251A	Değişken Kontaktlı Çift Platinli Change Over 1 From C	12	20A/30A	5	■	
	SR1251B					□	
	SR2451A		24	10A/20A	5	■	
	SR2451B					□	
	SR1256A		12	30A/50A	5	■	
	SR1256B					□	

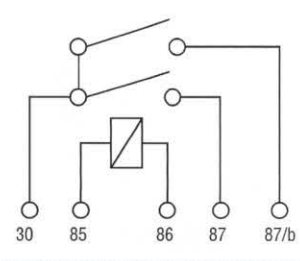

	Kod Code	Tarif Description	Volt	Amp.	Terminal	Braket Bracket	Bağlantı Şeması Connections
	SRD1251A	Diyotlu 1 Form C with Diode	12	20A/30A	5	■	
	SRD1251B					□	
	SRD2451A		24	10A/20A	5	■	
	SRD2451B					□	
	SRR1251A	Dirençli 1 Form C with resistance	12	20A/30A	5	■	
	SRR1251B					□	
	SRR2451A		24	10A/20A	5	■	
	SRR2451B					□	
	SR1252A	İki Çıkışlı Tek Platinli Double Output 2 Form A	12	2x20A	5	■	
	SR1252B					□	
	SR2452A		24	2x15A	5	■	
	SR2452B					□	
	SRD1252A	Diyotlu 2 Form A with diode	12	2x20A	5	■	
	SRD1252B					□	
	SRD2452A		24	2x15A	5	■	
	SRD2452B					□	
	SRR1252A	Dirençli 2 Form A with Resistance	12	2x20A	5	■	
	SRR1252B					□	
	SRR2452A		24	2x15A	5	■	
	SRR2452B					□	

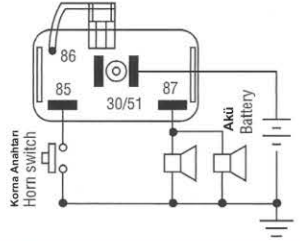
	Kod Code	Tarif Description	Volt	Amp.	Terminal	Braket Bracket	Bağlantı Şeması Connections
	SR2453	Normal Açık İki Kontakt İki Çıkış Normally Open Double contact Double Output	24	2x20A	5	■	
	SKR120	Normal Açık Kablolu Normally Open 1 Form A with cable	12	30A	4	■	

## Relay With Fuse / Sigortalı Röle

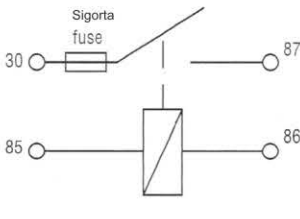
	SR1244	Normal Açık 30A Sigorta Normally Open 1 Form A 30A Fuse	12	30A	4	■	
	SR2444		24	30A	4	■	

## Micro Relay / Mikro Röle

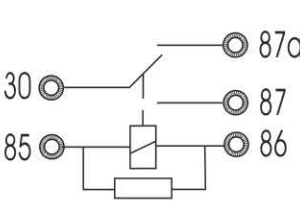
	SR1255	Değişken Kontaktlı Change Over 1 Form C	12	20A/25A	5	□	
	SR2455		24	10A/25A	5	□	



## Power Relays / Güç Rölesi

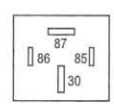
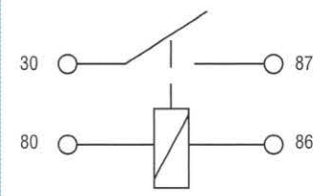

	Kod Code	Tarif Description	Volt	Amp.	Terminal	Braket Bracket	Bağlantı Şeması Connections
 	SR1245	Normal Açık Normally Open 1 Form A	12	80A	4	■	
	SR2445		24	40A	4	■	
	SR1245U		12	70A	4	□	

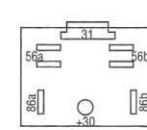
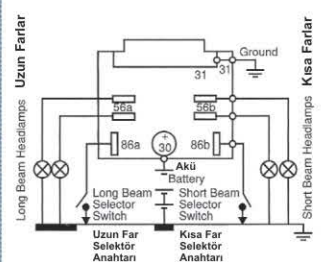
## Head Lamp Double Relays / Far Rölesi

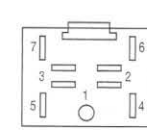
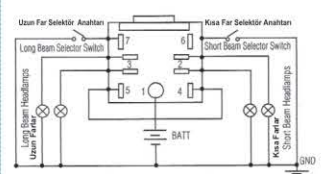
 	SLR012	Plastik Şase Plastic Socket Plate	12	2x30A	7	■	
	SR1206	Fiber Şase Fiber Socket Plate					
	SLR024	Plastik Şase Plastic Socket Plate	24	2x20A	7	■	
	SR2406	Fiber Şase Fiber Socket Plate					

 	SR1207	Fiber Şase Fiber Socket Plate	12	2x30A	9	■	
	SR2407		24	2x20A			

## Echo & Vibration Horn Relays / Yankılı ve Titreyen Röle

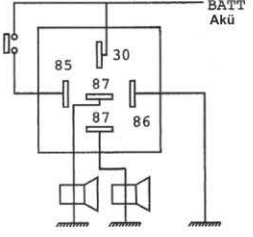
	Kod Code	Tarif Description	Volt	Amp.	Terminal	Braket Bracket	Bağlantı Şeması Connections
 	STR107	Normal Açık Normally Open	12	2x30A	5	□	
	STR108		24	2x20A	5	□	



Kornaları dakikada 150 defa titreştirir.  
Horn is on and off 150 cycles/min.

 	SYR112	Normal Açık Normally Open	12	20A/20A	4	■	
	SYR124		24	10A/10A	4	■	

Kornaları dakikada 150 defa değişimli çalıştırır.  
Horns are change overed 150 cycles/min.

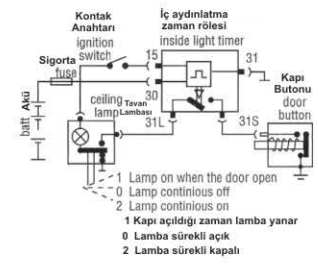

## Interior Light Timer / İç Aydınlatma Zaman Rölesi

	Araçlar Vehicles	Kod Code	Volt	Terminal	Amp.	Bağlantı Şeması Connections
		SLG485	12	5	8	
	Ford Fiat	SLG484	24	5	4	

Kapı açıldığında tavan lambasını yakar. Kapı kapatıldıktan 20 sn. sonra lamba söner. Lamba yanarken kontak çalıştırıldığında lambayı söndürür.

When the door is open, it switches on the light. After 20 seconds it switches off the lamp.  
If the ignition switch is ON, light switches OFF.

## Headlamp Washer Timer / Far Yıkama Rölesi

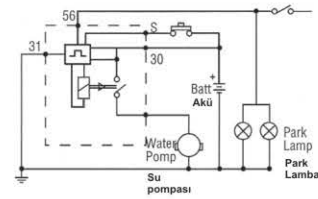
	Ford Fiat VW Seat	FYR90	12	5	8	
---	----------------------------	-------	----	---	---	---

Far yıkama butonuna basıldığında 0,5 sn süre ile far yıkama motoru çalıştırır.

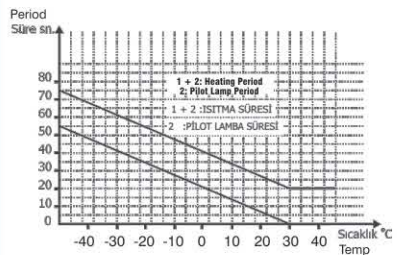

Activates head lamp washing motor work for 0,5 second when button is pressed.

## Pre and Post Heating Relay / Buji Kızdırma Rölesi

	Kod Code	Description	Volt	Amp.	Braket Bracket	
	SGH520	İçindeki işlemci, dış hava sıcaklığına göre kızdırma süresini ayarlar. Internal microchip, adjusts pre and post heating time according to outside temperature.	8.5V 16V	80A	■	

## Fog Lamp Relay / Sis Lambası Rölesi

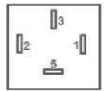
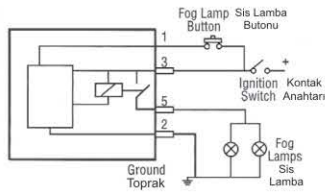
Sis lambalarının buton ile çalışmasını sağlar. Kontak kapatılıp açıldığında lambaları yakmaz.  
It lets foglamps work with button. After ignition is OFF, then ON, lamps don't turn ON.

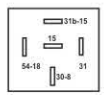
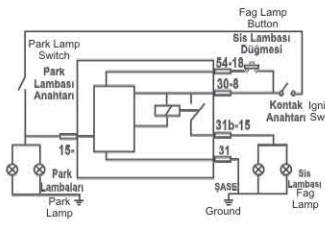
		Araçlar Vehicles	Kod Code	Volt	Terminal	Amp.	Bağlantı Şeması Connections
		Ford Isuzu Magirus Askam	SSS912	12	4	8	
			SSS924	24	4	8	
		Peugeot	SSS913	12	5	10	

Park lambalarına bağlı çalışır.  
Works according to park lamps

## Open Door Warning Timer / Açık Kapı İkaz Zaman Rölesi

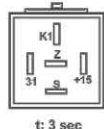
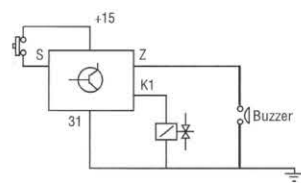
	 <p>t: 3 sec</p>		SKZ240	24	5	0,5	
---	---	--	--------	----	---	-----	---

## Flip Flop Door Open & Close Switch / Flip Flop Kapı Açma Kapama Rölesi

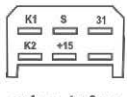
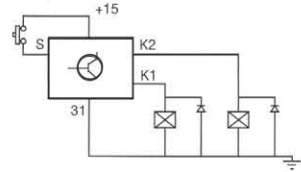
	 <p>tt: 1 sec tz: 3 sec</p>		SFF241	24	5	2x0,5	
---	--	--	--------	----	---	-------	---



## Flip Flop Open Door Warning Timer / Açık Kapı İkaz Zaman Rölesi

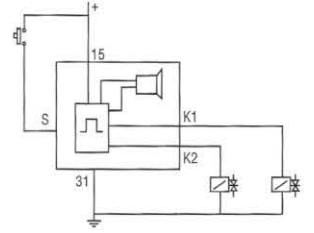

Araçlar Vehicles	Kod Code	Volt	Terminal	Amp.	Bağlantı Şeması Connections	
	M.A.N.	SKF242	24	6	K1,K2: 500mA (max)	

Butona basılınca K1 kapısı 1 sn içinde açılır.  
Butona tekrar basıldıktan sonra buzzer 3 sn sesli ikaz verir. Buzzer sustuğu anda K2 kapısı açılır.  
K1 door is opened after 1 sec. once button is pressed.  
Buzzer gives signal for 3 sec. when button is pressed again. When buzzer is off, K2 door does open.

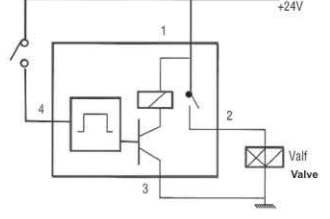

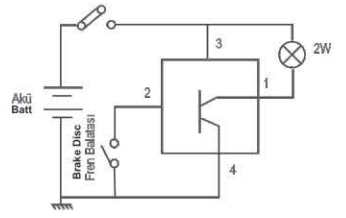

## Door Security Circuit / Kapı Emniyet Devresi

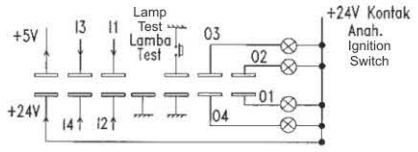
Araçlar Vehicles	Kod Code	Volt	Terminal	Braket Bracket	Bağlantı Şeması Connections
	SKE211	24	4	□	

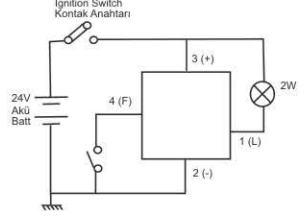

## Brake Disc Circuit / Fren Balatası Devresi

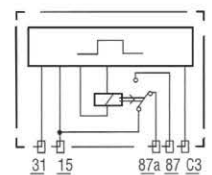
	SFB210	24	4	□	
Araçtaki herhangi bir fren balatasının aşındığını gösterir. Indicates failure of brake disc units					
	SFB209	24	13	■	
Araçtaki 4 fren balatasından hangisi aşındıysa onu gösterir. Indicates which brake disc unit is failed.					

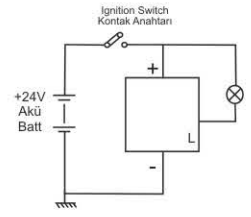
# Warning Units / İkaz Ünitesi



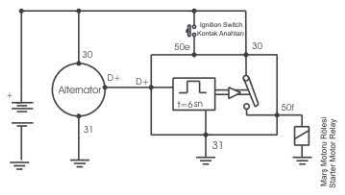







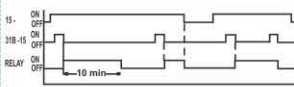

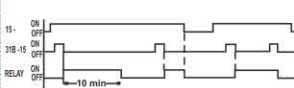
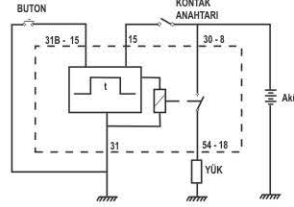
Araçlar Vehicles	Kod Code	Tarif Description	Volt	Terminal	Km/h	Braket Bracket	Bağlantı Şeması Connections
	SHS012	High Speed Warning Unit	12	4	90	■	
	SLI060	Door Lock Unit	24	5	3	□	
	SVI041	Low Voltage Warning Unit 24.6 V	24	3	-	□	

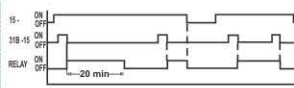

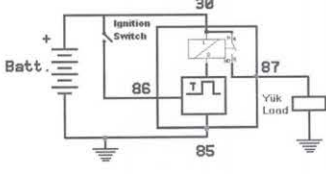

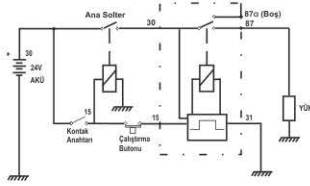

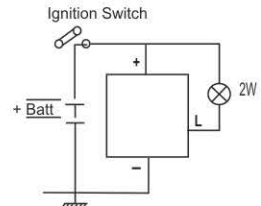

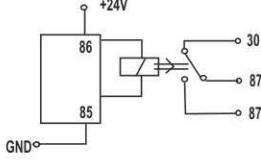

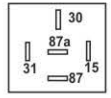
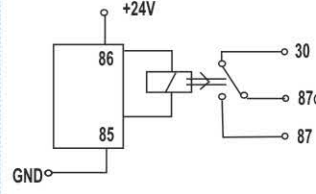

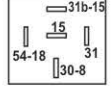
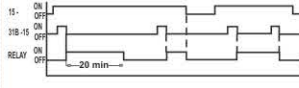
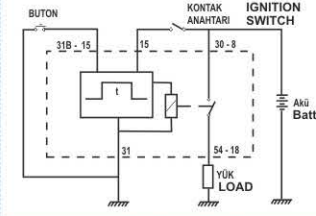

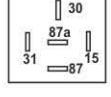
# Start Repeat Locking / Marş Koruma Rölesi

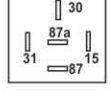
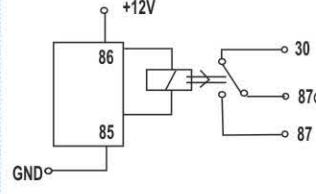
	SMK141	Marş butonu ON olunca marş motoru çalışır. Buton OFF yapıldıktan sonra tekrar motorun çalışabilmesi için 6 sn bekletilir.	24	5	■	
	SMK142	It locks restarting the engine for 6 seconds. If there is voltage on D(+) it prevents engine start.	12	5	■	

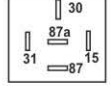

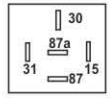
# Multi Purpose Timer Relays / Çok Amaçlı Zaman Röleleri

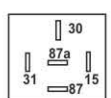
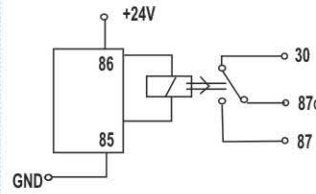

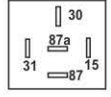

	Kod Code	Tarif Description	Volt	Terminal	Amp.	Zaman Time	Bağlantı Şeması Connections
	SRT945		12	5	23A	10 min. 10 Dak.	Arka cam, yan cam, ön cam yan ayna, ısıtıcı zaman röleleri Rear, front windshield, side window, side mirror, heating timer relay
	SRT946		24	5	10A	10 min. 10 dak.	
	SRT948		24	5	20A	20 min. 20 dak.	
	SRT949	- (85) + (86) 24V gerilim uygulandığında röle sürekli çeker. Gerilim kesildikten 2 dakika sonra röle bırakır. After applying 24V to -(85) +(86) the relay is activated and when the voltage is cut, after 2 minutes relay gets deactivated	24	4	8A	2 min. 2 dak.	
	SRT951		24	5	20A	30 min. 30 dak.	
	ST212	- ve + uçlarına 12V gerilim uygulanınca şoför önündeki ikaz lambasını 2±1 sn süre boyunca yakar. After applying 12V to - and + pins, the pilot lamp is activated and after 2±1 sec. gets deactivated.	12	3	150 mA	2 sn. 2 sec.	
	ST213	- ve + uçlarına 24V gerilim uygulanınca şoför önündeki ikaz lambasını 2±1 sn süre boyunca yakar. After applying 24V to - and + pins, the pilot lamp is activated and after 2±1 sec. Gets deactivated.	24	3	150 mA	2 sn. 2 sec.	
	ST245	- (85) +(86) 24V gerilim uygulandıktan 3±0.2 sn sonra devre röleyi çektilir. After applying 24V to -(85) +(86), the relay activation is delayed for 3±0.2 sec	24	5	10A	3 sn. 3 sec.	





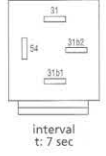
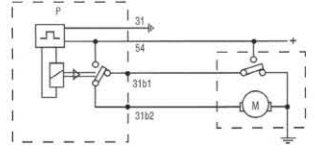

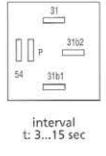
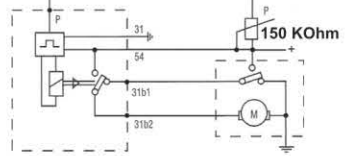

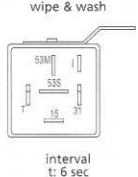
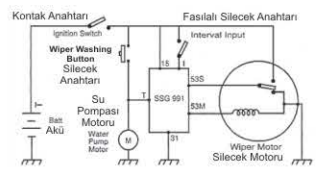
	Kod Code	Tarif Description	Volt	Terminal	Amp.	Zaman Time	Bağlantı Şeması Connections
		ST246 -(85) +(86) 24V gerilim uygulandıktan 1±0.2 sn sonra devre röleyi çektirir.  After applying 24V to -(85) +(86), the relay activation is delayed for 1±0.2 sec	24	5	10A	1 sn. 1 sec.	
		T12M20 	12	5	23A	20 dak. 20 min.	
		T12S3 -(85) +(86) 12V gerilim uygulandıktan 3±1 sn sonra röleyi çektirir.  After applying 12V to -(85) +(86), the relay activation is delayed for 3±1 sec	12	5	10A	3 sn. 3 sec.	
		T12S5 -(85) +(86) 12V gerilim uygulandığında röle çeker, 5 sn sonra bırakır  After applying 12V to -(85) +(86) the relay is activated and after 5 sec. gets deactivated	12	5	10A	5 sn. 5 sec.	
		T12S90 -(85) +(86) 12V gerilim uygulandıktan 90±10 sn sonra devre röleyi çektirir.  After applying 12V to -(85) +(86), the relay activation is delayed for 90±10 sec	12	5	10A	90 sn. 90 sec.	
		T24M2 -(85) +(86) 24V gerilim uygulandıktan 120 sn sonra röle çeker.  After applying 24V to -(85) +(86), the relay activation is delayed for 120 sec	24	5	10A	2 dak. 2 min.	
		T24S0-5 -(85) +(86) 24V gerilim uygulandığında röle çeker, 0.5±0.1sn sonra röle bırakır.  After applying 24V to -(85) +(86) the relay is activated and after 0.5±0.1 sec. gets deactivated	24	5	10A	0.5 sn 0.5 sec.	
		T24S30 -(85) +(86) 24V gerilim uygulandığında röle çeker, 30±5 sn sonra röle bırakır.  After applying 24V to -(85) +(86), the relay is activated and after 30±5 sec. gets deactivated	24	5	10A	30 sn. 30 sec.	

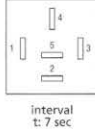

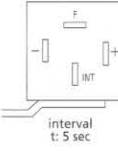

# WIPER TIMERS / SİLECEK ZAMAN RÖLESİ

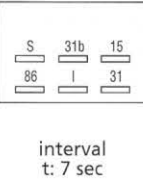
		Araçlar Vehicles	Kod Code	Volt	Terminal	Braket Bracket	Bağlantı Şeması Connections
	 interval t: 7 sec	Ford Fiesta Escort Taurus Orion Cargo	SSG884	12	4	Klips Clip	
			SSG885	24	4	Klips Clip	
	 interval t: 3...15 sec	Ford Escort	SRS943	12	5	□	
 	 wipe & wash interval t: 6 sec	Peugeot Opel VW Skoda Audi Citroen	SSG991	12	6	■	
		SSG993	24	6	■		
		SSG992	12	6	■		

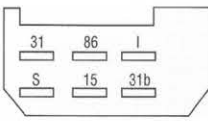
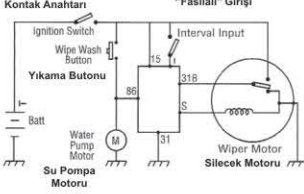
		Araçlar Vehicles	Kod Code	Volt	Terminal	Braket Bracket	Bağlantı Şeması Connections
<p>Arka cam silecek zaman rölesi Rear windshield wiper timer relay</p> 		Ford	SAS944	12	5	□	
		Fiat Doğan Şahin	SSG990	12	4	■	
			SSG989	24	4	□	
			SSG996	12	4	□	
		Lada	SSG886	12	6	□	
		M.A.N. Mercedes Volvo	SSG994	12	6	■	
			SSG995	24	6	■	
							





# LEVEL SENSORS / SEVİYE İKAZ RÖLESİ





SANEL®  
AUTO ELECTRONIC

## Water Level Warning Relay / Su Seviye İkaz Rölesi

Araçlar Vehicles	Kod Code	Tarif Description	Volt	Amp.	Terminal	Bağlantı Şeması Connections
---------------------	-------------	----------------------	------	------	----------	--------------------------------

Herhangi bir yerdeki sıvı seviyesi azalmasını kontrol etmek için kullanılır. Her kontak açılışında kendini otomatik test eder. 0,7 saniye süre ile ikaz lambası yanar ve alarm sesi gelir. Su tankındaki su seviyesi probun altına düştüğünde 1 saniye gecikme ile şoförü ikaz eder. (Gecikme dalgalanmalardan etkilenmemek içindir.)

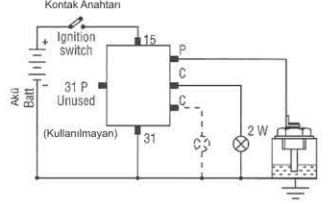
Controls the water level in water tanks. It tests itself automatically. When engine starts. The pilot lamp turns on for 0,7 seconds and buzzer beeps. When water level in Tank dropped under the prob level, it waits 1 second then Warns the driver to delay waves

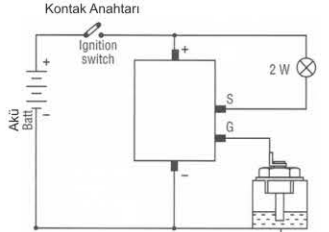
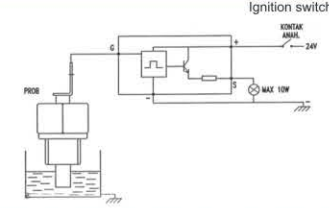
 	Ford Isuzu	LLS931	70 dB sesli ikaz + oto kontrol 70 dB sound warning + With Self Control	12	0,5	6	
		LLS932	24	0,5	6		
 	Mercedes	LLS934	Self Control	12	0,3	4	
		LLS933		24	0,3	4	
		LLS963		24	0,3	4	

Araçlar Vehicles	Kod Code	Tarif Description	Uzunluk Length
---------------------	-------------	----------------------	-------------------

	LLP941	Su seviye ikaz ile birlikte kullanılır Ø5mm stainless steel / It is used with water level warnings	30mm -370 mm
---	--------	--	--------------

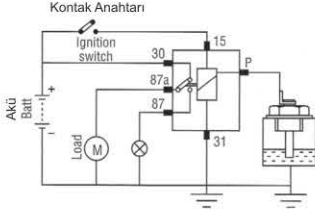
	Kod Code	Tarif Description	Volt	Amp.	Terminal	Bağlantı Şeması Connections
<p>Jeneratör radyatöründeki sıvı seviyesi azalmasını kontrol etmek için kullanılır. Su seviyesi probun altına düştüğünde içindeki röle ile motoru kapatır ve ikaz verir.</p> 	LLR937	Jeneratör Radyatörü Kontrolü için 16A Röle	12	16	6	
	LLR938	16A Relay For Generator Radiator Control	24	8	6	

## Water Detector In Fuel Filter / Yakıt Filtresi Su Dedektörü

Mazot filtresindeki su seviyesi artınca şöföre ikaz verir.

Gives a warning signal when the water level in fuel filter is above the prob level.







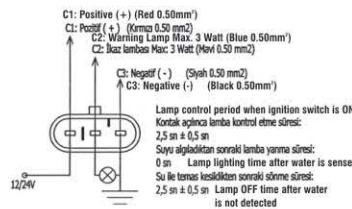
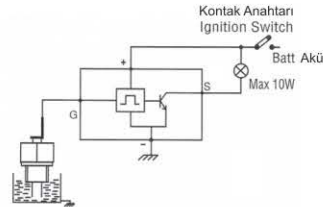





İlave YSD201P probu ile kullanılır.  
Used with an additional prob YSD201P

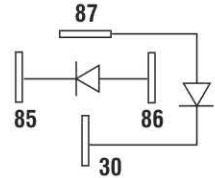

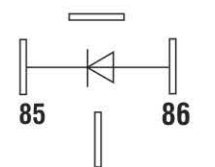

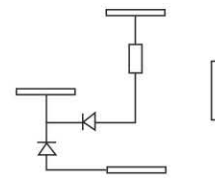

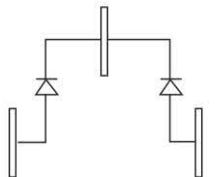

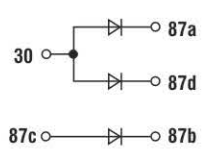

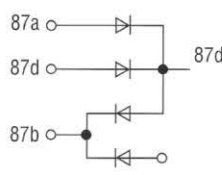

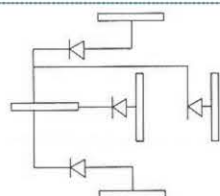

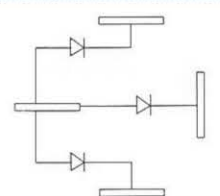
YSD201	Oto Kontrol with Self Control	12	0,5	4
YSD224		24	0,3	4
YSD223		9...30	0,3	4

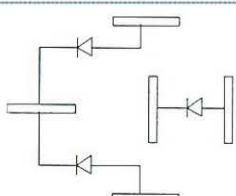

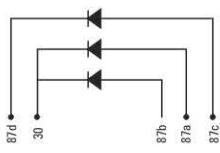

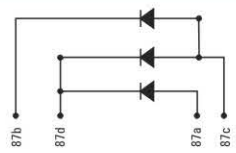

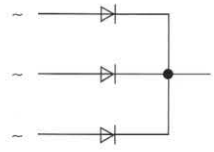

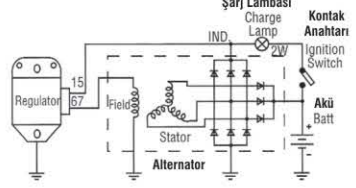

	Kod Code	Ölçüler Dimensions	Amp.	Bağlantı Şeması Connections
	SDT902	Ø=110mm	25A	
	SDT903	Ø=105mm	25A	
	SDT905	L=19,5mm	25A	
	SDT906	28,5(L)x28,5(W) x38,5(H)	2x6A	
	SDT907	28,5(L)x28,5(W) x38,5(H)	6A	
	SDT908	30(L)x30(W) x41(H)	2x1A	
	SDT909	28,5(L)x28,5(W) x38,5(H)	2x3A	
	SDT910	28,5(L)x28,5(W) x38,5(H)	3A	

	Kod Code	Ölçü Size	Amp.	Bağlantı Şeması Connections
	SDT911	30(L)x30(W) x41(H)	3A	
	SDT916	30(L)x30(W) x41(H)	4x3A	
	SDT917	30(L)x30(W) x41(H)	3x3A	
	SDT918	28,5(L)x28,5(W) x38,5(H)	2x6A 1x3A	
	SDT921	Kablo uzunluğu 80 mm Cable length 80 mm		
	SDT925	30(L)x30(W) x41(H)	3A	
	SDT926	28,5(L)x28,5(W) x38,5(H)	3A	
	SDT900		3x 2.5A	

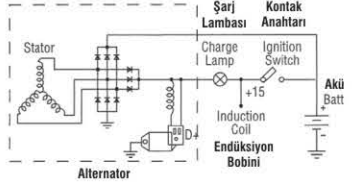

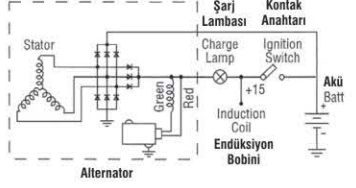
## Alternator Generator Regulators / Alternatör Regülatörü

	Araçlar Vehicles	Kod Code	V Nom	V Out	Bağlantı Şeması Connections
 <div style="border: 1px solid black; padding: 2px; display: inline-block;">15 67</div>		SR9312	12	14.2	
	Dizel araçlar için For diesel vehicles	SR9312D	12	13.8	
		SR9324	24	28.2	
	Fiat	SR9912	12	14.2	
		SR9924	24	28.2	
	Fiat	MR98	12	14.2	

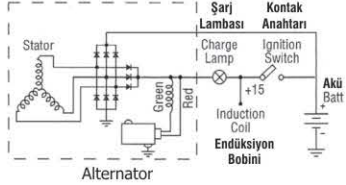
	Araçlar Vehicles	Kod Code	V Nom	V Out	Bağlantı Şeması Connections
	Fiat	SR114A	12	14.2	
		SR128A	24	28.2	

## Flywheel Magnet Regulator / Magneto Regülatörü

	25 Ampere	Fiat	SRR685	12	14.2	
						

## Over Voltage Protection / Aşırı Voltaj Koruma

Akü gerilimi aşırı yükseldiğinde alternatörün gerilim üretmesini keser. Akü ikaz lambasını yakar.

When battery is over voltage, it stops alternator to produce voltage. And turns on battery warning pilot lamp.

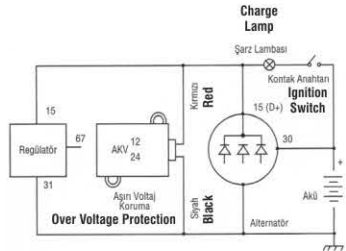
	Fiat	AVK012	12	16.5	
		AVK024	24	32.7	







## Buzzers / Buzzer

	Kod Code	Ø(mm)	h (mm)	dB (1mm)	Volt	f (Hz)	Ton Tone
	SB888	32	20	83	12-24	2700	Kesikli Pulse
	SB890	32	20	83	12-24	2700	Sürekli Continuous
Açık kapı ikaz buzzeri Open door warning buzzer	SB895	-	-	70	12	-	Sürekli Continuous
	SB896	-	-	70	24	-	Sürekli Continuous

## Back Horns / Geri Vites İkaz Kornası





	Kod Code	Ø(mm)	h (mm)	dB (1mm)	Volt	f (Hz)	Ton Tone
<p>Su geçirmez Water Proof</p> 	SBH834	55	52	>94dB (v=28V) >86dB (v=14V)	9...32	-	Kesikli Pulse
 <p>Belediye otobüsleri için duracak ikazı Stop warning for local transport buses</p>	SDH001	54	45	80	24	-	Ding Dong

## Sirens / Sirenler

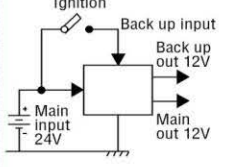

	SMS939	54	57	97	12	1300	Siren
	SMS940	100	87	120	12	-	6 Farklı Ton 6 Different tones
	SMS960	54	57	97	12V AC	1300	Motosiklet sireni Motorcycle horn

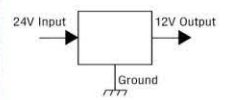
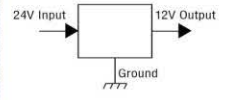

## Linear Converters / Lineer Konvertör

Kod Code	Çalışma Gücü Rating Watt	Giriş Voltajı Input Voltage	Çıkış Voltajı Output Voltage	Çıkış Akımı Output Current	Boyut Dimension	Ağırlık Weight	Kısa Devre Koruma Short Circuit Protection	Aşırı Voltaj Koruma Over Voltage Protection	Radyo Hafıza Çıkışı Radio Memory Back-up	Bağlantı Şeması Connections
 SCM2405	60W	18V-32V	13.5V ± 0.5V	5A	116 x 90 x 62	340gr	■	■	■ 13V ± 2V	
 SC2405	60W	18V-32V	13.5V ± 0.5V	5A	116 x 90 x 62	315gr	■	■	□	
SC2475	90W	18V-32V	13.5V ± 0.5V	7,5A	116 x 125 x 62	365gr	□	■	□	
SC2410	120W	18V-32V	13.5V ± 0.5V	10A	116 x 160 x 62	584gr	■	■	□	
 SC2415	180W	18V-32V	13.5V ± 0.5V	15A	116 x 210 x 62	740gr	■	■	□	
SC2420	240W	18V-32V	13.5V ± 0.5V	20A	116 x 270 x 62	971gr	■	■	□	

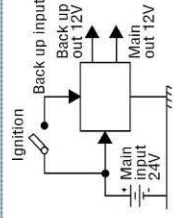
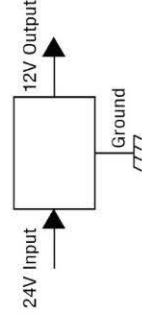
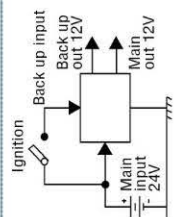
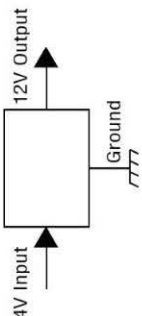
# Switchmode Converters / Switchmod Konvertör

	Kod Code	Çalışma Gücü Rating Watt	Giriş Voltajı Input Voltage	Çıkış Voltajı Output Voltage	Çıkış Akımı Output Current	Boyut Dimension	Ağırlık Weight	Kısa Devre Koruma Over Current Protection	Aşırı Voltaj Koruma Over Voltage Protection	Aşırı Sıcaklık Koruma Over Temp. Protection	Soft Start	Fan	Radyo Hafıza Çıkışı Radio Memory Back-up	Bağlantı Şeması Connections
	SMC10	120W	18V-32V	14.2V ± 0.2V	10A	90 x 110 x 45	340gr	12A	■	■	■	□	■	
	SMC101	120W	18V-32V	14.2V ± 0.2V	10A	90 x 110 x 45	340gr	12A	■	■	■	□	□	
	SMC15	180W	18V-32V	14.2V ± 0.2V	15A	90 x 110 x 45	376gr	18A	■	■	■	□	□	
	SMC15M	180W	18V-32V	14.2V ± 0.2V	15A	90 x 110 x 45	376gr	18A	■	■	■	□	■	
	SCA10	120W	18V-32V	14.2V ± 0.2V	10A	90 x 110 x 57	350gr	12A	■	■	■	□	□	
	SCA15	180W	18V-32V	14.2V ± 0.2V	15A	90 x 110 x 57	365gr	18A	■	■	■	■	□	

**Recessed Mount Fluorescent Fittings / Floresan Aydınlatma Gömme Tip Montaj**

	Kod Code	Ampul Gücü Tube Power	Beslenme Gerilimi Supply Voltage	Max Akım Max Current	Boyut Dimensions
 	SFA1208	8W	12	0,8A	398 (L) X 145 (W) X 42 (H) mm
	SFA2408	8W	24	0,4A	398 (L) X 145 (W) X 42 (H) mm
 	SFA1216	2X8W	12	1,6A	398 (L) X 145 (W) X 42 (H) mm
	SFA2416	2X8W	24	0,8A	398 (L) X 145 (W) X 42 (H) mm
 	SFA1218	18W	12	1,7A	700 (L) X 145 (W) X 42 (H) mm
	SFA2418	18W	24	0,8A	700 (L) X 145 (W) X 42 (H) mm



**Options:**

N: Night Light / Gece Lambası  
D: Dimming / Işığı Kıasma  
L: Long-Life / Uzun Ömür

Poly-carbonate lens / Polikarbonat Cam  
Aluminium Chassis / Alüminyum Profil



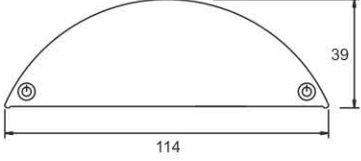

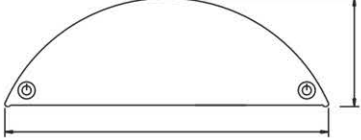
## Surface Mount Fluorescent Fittings / Floresan Aydınlatma Yüzey Tip Montaj

	Kod Code	Ampul Gücü Tube Power	Beslenme Voltaj Supply Voltage	Max Akım Max Current	Boyut Dimensions
 	SPB2408FAA	8W	24V	320mA ± 60	445(L) x 114(W) x 39(h) mm
	SPB2416FAA	2X8W	24V	640mA ± 50	445(L) x 114(W) x 39(h) mm
 	SPB2413FAA	13W	24V	600mA ± 50	675(L) x 114(W) x 39(h) mm
	SPB2426FAA	2X13W	24V	1200mA ± 50	675(L) x 114(W) x 39(h) mm

### Options:

Night Light / Gece Lambası  
Dimming / Işığın Kısmı  
Long-Life / Uzun Ömür  
Loudspeaker / Hoparlör

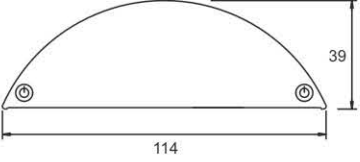
Poly-carbonate lens / Polikarbonat Cam  
Aluminium Chassis / Alüminyum Profil

	Kod Code	Ampul Gücü Tube Power	Beslenme Gerilimi Supply Voltage	Max Akım Max Current	Boyut Dimensions
	SPB2414FAA	14W	24V	700mA ± 70	705(L) x 114(W) x 39(h) mm
	SPB2428FAA	2x14W	24V	1400mA ± 200	705(L) x 114(W) x 39(h) mm
	SPB2421FAA	21W	24V	900mA ± 100	1007(L) x 114(W) x 39(h) mm
	SPB2428FAB	28W	24V	1100mA ± 100	1307(L) x 114(W) x 39(h) mm
	SPB2435FAA	35W	24V	1400mA ± 200	1607(L) x 114(W) x 39(h) mm

**Options:**

N: Night Light / Gece Lambası  
D: Dimming / Işığı Kısmı  
L: Long-Life / Uzun Ömür  
S: Loudspeaker / Hoparlör

Poly-carbonate lens / Polikarbonat Cam  
Aluminium Chassis / Alüminyum Profil

	Kod Code	Ampul Gücü Tube Power	Beslenme Gerilimi Supply Voltage	Max Akım Max Current	Boyut Dimensions
	SFL984	2x6W	12	0,7A	233 (L) x 60 (W) x 27 (H) mm
	SFL985	2x6W	24	0,5A	233 (L) x 60 (W) x 27 (H) mm

## Festoon Lamps / Sofit Lamba

	STL701	4x5W	12	2A	233 (L) x 60 (W) x 27 (H) mm
	STL702	4x5W	24	1A	233 (L) x 60 (W) x 27 (H) mm

## Bulb Lamps / Ampullü Tavan Lambası

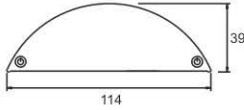
  <p>Options: Night Light / Gece Lambası Poly-carbonate lens / Polikarbonat Cam Aluminium Chassis / Alüminyum Profil</p>	STL703	2x10W	12	1,5A	250 (L) x 114 (W) x 39 (H) mm
	STL704	2x10W	24	0,75A	250 (L) x 114 (W) x 39 (H) mm



	Kod Code	Beslenme Voltajı Supply Voltage	Max Akım Max Current	Led Rengi Led Colour	Led Adedi Led Quantity	Ölçüler Dimensions
 <p>İsteğe bağlı gövde renkleri Various body colours</p>	SSL12W18	12	200mA	Beyaz White	18	Geniş Açı Aydınlatma Wide Angle Lighting  Ø75 x 23,5 mm
	SSL12Y18	12	200mA	Sarı Yellow	18	
	SSL12B18	12	200mA	Mavi Blue	18	
	SSL12R18	12	200mA	Kırmızı Red	18	
	SSL24W18	24	100mA	Beyaz White	18	
	SSL24Y18	24	100mA	Sarı Yellow	18	
	SSL24B18	24	100mA	Mavi Blue	18	
	SSL24R18	24	100mA	Kırmızı Red	18	
	 <p>Ø 60'lık yuvaya klipsleri sayesinde Monte edilir. Derinlik 22 mm Opsiyonel sızdırmazlık. Mountable Ø 60 with clips. Depth 22 mm Optional water proof.</p>	SSL12W24	12	300mA	Beyaz White	
SSL12Y24		12	300mA	Sarı Yellow	24	
SSL12B24		12	300mA	Mavi Blue	24	
SSL12R24		12	300mA	Kırmızı Red	24	
SSL24W24		24	150mA	Beyaz White	24	
SSL24Y24		24	150mA	Sarı Yellow	24	
SSL24B24		24	150mA	Mavi Blue	24	
SSL24R24		24	150mA	Kırmızı Red	24	
<p>Su Geçirmez Waterproof</p> 		SBA12R3	12	30mA	Kırmızı Red	3
	SBA12Y3	12	30mA	Sarı Yellow	3	84,3(L) x29,80(W)x17,3(h) mm
	SBA24R3	24	30mA	Kırmızı Red	3	84,3(L) x29,80(W)x17,3(h) mm
	SBA24Y3	24	30mA	Sarı Yellow	3	84,3(L) x29,80(W)x17,3(h) mm

Kod Code	Beslenme Voltajı Supply Voltage	Max Akım Max Current	Led Rengi Led Colour	Led Adedi Led Quantity	Ölçüler Dimensions (mm)
----------	---------------------------------	----------------------	----------------------	------------------------	-------------------------

Su Geçirmez / Waterproof



Arka görünüş / Rear view

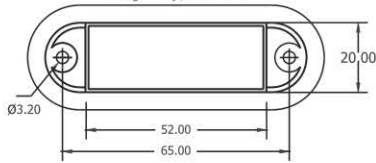

Mounting dimensions  
Montaj yuva boyutları  
En / width :20 mm  
Boy / lenght :52 mm  
Derinlik / height :16 mm

SBA24W3	24	30mA	Beyaz White	3	84,3(L) x 29,80(W) x 17,3(h)
SBA24R6	24	30mA	Kırmızı Red	6	84,3(L) x 29,80(W) x 17,3(h)
SBA24B6	24	30mA	Mavi Blue	6	84,3(L) x 29,80(W) x 17,3(h)
SBA24W6	24	30mA	Beyaz White	6	84,3(L) x 29,80(W) x 17,3(h)
SBA24B3	24	30mA	Mavi Blue	3	84,3(L) x 29,80(W) x 17,3(h)
SBA12W3	12	30mA	Beyaz White	3	84,3(L) x 29,80(W) x 17,3(h)

**Options:**

Poly-carbonate Lens / Polikarbonat Cam

Epoxy sealing, water resist / Epoksi Dolgu, su geçirmez

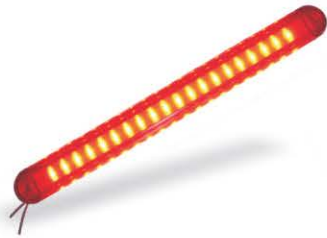

Montaj yuva boyutları  
Mounting dimensions  
En / width : 18.5 mm  
Boy / lenght : 242 mm  
Derinlik / height: 17 mm

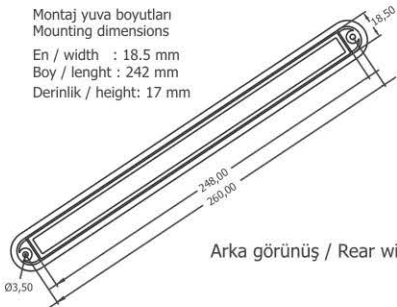

Arka görünüş / Rear view



Su Geçirmez / Waterproof

SBA12R20	12	300mA	Kırmızı Red	20 chipleds	278(L) x 26,5(W) x 16,5(h)
SBA12B20	12	300mA	Mavi Blue	20 chipleds	278(L) x 26,5(W) x 16,5(h)
SBA12W20	12	300mA	Beyaz White	20 chipleds	278(L) x 26,5(W) x 16,5(h)
SBA24R20	24	150mA	Kırmızı Red	20 chipleds	278(L) x 26,5(W) x 16,5(h)
SBA24B20	24	150mA	Mavi Blue	20 chipleds	278(L) x 26,5(W) x 16,5(h)
SBA24RB20	24	150mA	Kırmızı / Mavi Red / Blue	20 chipleds	278(L) x 26,5(W) x 16,5(h)
SBA24W20	24	150mA	Beyaz White	20 chipleds	278(L) x 26,5(W) x 16,5(h)
SBA12R12	12	200mA	Kırmızı Red	12 Highflux leds	278(L) x 26,5(W) x 16,5(h)
SBA12B12	12	200mA	Mavi Blue	12 Highflux leds	278(L) x 26,5(W) x 16,5(h)
SBA12W12	12	200mA	Beyaz White	12 Highflux leds	278(L) x 26,5(W) x 16,5(h)
SBA24R12	24	100mA	Kırmızı Red	12 Highflux leds	278(L) x 26,5(W) x 16,5(h)
SBA24B12	24	100mA	Mavi Blue	12 Highflux leds	278(L) x 26,5(W) x 16,5(h)
SBA24W12	24	100mA	Beyaz White	12 Highflux leds	278(L) x 26,5(W) x 16,5(h)



	Kod Code	Beslenme Voltajı Supply Voltage	Max Akım Max Current	Led Rengi Led Colour	Ölçüler Dimensions
	SPB2430LAA	24V	200mA	Beyaz White	158(L) x 114(W) x 39(h) mm

Poly-carbonate lens / Polikarbonat Cam  
Aluminum Chassis / Alüminyum Profil

## Pictogram / Piktogram

Araçlar Vehicle	Kod Code	Volt	Ölçüler Dimensions	Tarif Description
	Okul Servisleri School Bus SPG124	9...32V	400(L) x 400(W) x 50(h) mm	<p>Kapı anahtarından açıldı sinyali geldiğinde ledler yanıp sönmeye başlar. Kapı anahtarından kapandı sinyali geldikten 20 sn sonra ledler söner.</p> <p>Pictogram device designed for school bus vehicles. While the passengers get off or get on the vehicle the LEDs' blink. The LEDs' continue to blink for 20 sec. after the vehicle door is shut.</p> <p>Yüksek kalite reflektör Polikarbonat lens Yüksek parlaklıkta ledler</p>
	Okul Servisleri School Bus SPG126	9...32V	200(L) x 200(W) x 50(h) mm	

## Destination Sign / Yön Gösterge Panosu

	Kod Code	Ölçüler Dimensions	Tarif Description
	SYG720	753 (L) x 206 (W) x 37 (H) mm	<p>Floresan lamba Kolaylıkla hat değiştirme özelliği</p> <p>Fluorescent lamp. Easy change of text panel</p> <p>Ölçüleri isteğe göre değiştirilir Various Dimensions</p>





# ELECTRONIC FLUORESCENT INVERTERS / ELEKTRONİK FLORESAN BALAST

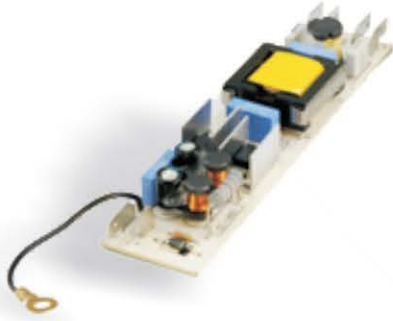

Long Life / Uzun Ömür  
(>250.000 cycles)

Step dimming / Kademeli Dimmer  
(%65 or %35 of Light)

Flicker Free / Titreşimsiz Işık

EMC Complied / EMC Uyumlu

Filament Heated / Filaman Isıtmalı





Internal Fuse / Dahili Sigorta

Protected Against Reverse Connection  
Ters Bağlantı Korumalı



Kod Code	Volt	Güç Watt	Uzun Ömür Long Life	Dimmer	En (mm) W (mm)	Boy (mm) L (mm)	Yükseklik (mm) H (mm)
EFB1218	12V	18W	□	□	38	167	28
EFB1236	12V	36W	□	□	38	167	28
EFB1218U	12V	18W	■	□	38	172	28
EFB1236U	12V	36W	■	□	38	172	28
EFB1218UD	12V	18W	■	■	38	172	28
EFB1236UD	12V	36W	■	■	38	172	28
EFB1208	12V	8W	□	□	38	167	28
EFB1208U	12V	8W	■	□	38	172	28
EFB1208UD	12V	8W	■	■	38	172	28
EFB1213	12V	13W	□	□	38	167	28
EFB1213U	12V	13W	■	□	38	172	28
EFB1213UD	12V	13W	■	■	38	172	28
EFB1221	12V	21W	□	□	38	167	28
EFB1221U	12V	21W	■	□	38	172	28
EFB1221UD	12V	21W	■	■	38	172	28
EFB1228	12V	28W	□	□	38	167	28
EFB1228U	12V	28W	■	□	38	172	28
EFB1228UD	12V	28W	■	■	38	172	28
EFB1235	12V	35W	□	□	38	167	28
EFB1235U	12V	35W	□	□	38	172	28
EFB1235UD	12V	35W	■	■	38	172	28
EFB2418	24V	18W	□	□	38	167	28
EFB2436	24V	36W	□	□	38	167	28
EFB2418U	24V	18W	■	□	38	172	28
EFB2436U	24V	36W	■	□	38	172	28
EFB2418UD	24V	18W	■	■	38	172	28
EFB2436UD	24V	36W	■	■	38	172	28
EFB2408	24V	8W	□	□	38	167	28
EFB2408U	24V	8W	■	□	38	172	28
EFB2408UD	24V	8W	■	■	38	172	28
EFB2413	24V	13W	□	□	38	167	28
EFB2413U	24V	13W	■	□	38	172	28
EFB2413UD	24V	13W	■	■	38	172	28
EFB2421	24V	21W	□	□	38	167	28
EFB2421U	24V	21W	■	□	38	172	28
EFB2421UD	24V	21W	■	■	38	172	28
EFB2428	24V	28W	□	□	38	167	28
EFB2428U	24V	28W	■	□	38	172	28
EFB2428UD	24V	28W	■	■	38	172	28
EFB2435	24V	35W	□	□	38	167	28
EFB2435U	24V	35W	■	□	38	172	28
EFB2435UD	24V	35W	■	■	38	172	28



## Recessed Mount / Gömme Tip Montaj

	Kod Code	Volt	Sıcaklık Göstergesi Temperature Display	Boyut (mm) Dimensions	Gösterge Boyutu Display Size	
	SDS312	24	■	200(L) x 48(W) x 70(H)mm	1,5" 38mm.	50 saniye zaman, 10 saniye sıcaklık göstergeli  50 seconds time, 10 seconds temperature display
	SDS313	24	□	200(L) x 48(W) x 70(H)mm	1,5" 38mm.	
	SDS314	12	■	200(L) x 48(W) x 70(H)mm	1,5" 38mm.	50 saniye zaman, 10 saniye sıcaklık göstergeli  50 seconds time, 10 seconds temperature display
	SDS315	12	□	200(L) x 48(W) x 70(H)mm	1,5" 38mm.	

## Surface Mount / Yüzey Tip Montaj



	Kod Code	Volt	Sıcaklık Göstergesi Temperature Display	Boyut (mm) Dimensions	Gösterge Boyutu Display Size	
	SDS308	24	□	(L)118 x (W)21 x (H)62	1"	<p>50 saniye zaman, 10 saniye sıcaklık göstergeli</p> <p>50 seconds time, 10 seconds temperature display</p>
	SDS309	24	■	(L)118 x (W)21 x (H)62	1"	
	SDS310	12	□	(L)118 x (W)21 x (H)62	1"	
	SDS311	12	■	(L)118 x (W)21 x (H)62	1"	

	Kod Code	Tarif Description	Uzunluk Length
	STS802	<p>kablo / dijital saat ile birlikte kullanılır</p> <p>cable / it is used with digital bus clock</p>	Değişken / Variable













## Recessed Mount / Gömme Tip Montaj

	Kod Code	Volt	Tarif Description	Boyut (mm) Dimensions	Yazı Display
	SSI751	12V	3x5W Sofit Lamba Festoon lamp	200(L) x 48(W) x 70(h) mm	STOP
	SSI750	24V	3x5W Sofit Lamba Festoon lamp	200(L) x 48(W) x 70(h) mm	STOP
	SDI761	12V	3x5W Sofit Lamba Festoon lamp	200(L) x 48(W) x 70(h) mm	DURACAK
	SDI760	24V	3x5W Sofit Lamba Festoon lamp	200(L) x 48(W) x 70(h) mm	DURACAK
	STI774	24V	2x10W Sofit Lamba Festoon lamp	200(L) x 48(W) x 70(h) mm	KEMER&WC BELT&WC
	STI775	12V	2x10W Sofit Lamba Festoon lamp	200(L) x 48(W) x 70(h) mm	KEMER&WC BELT&WC

	Kod Code	Volt	Tarif Description	Boyut (mm) Dimensions	Yazı Display
	SSI752	24	Led lamp	118(L) x 21(W) x 62(h) mm	STOP
	SSI753	12	Led lamp	118(L) x 21(W) x 62(h) mm	STOP
	STI770	24	Led lamp	118(L) x 21(W) x 62(h) mm	WC
	STI771	12	Led lamp	118(L) x 21(W) x 62(h) mm	WC
	STI772	24	Led lamp	118(L) x 21(W) x 62(h) mm	KEMER&WC BELT&WC
	STI773	12	Led lamp	118(L) x 21(W) x 62(h) mm	KEMER&WC BELT&WC



# STOP BUTTONS / STOP BUTONLARI

Araçlar Vehicles	Kod Code	Tip Type	Gövde Rengi Body Colour	Buton Rengi Button Colour	Adaptör	Yazı / Figür Text / Figure	Yazı / Figür Görünüm Text / Figure View	
       	Belediye Otobüsü Public Bus	SSB860	Boru For round handrails	Gri Gray	Kırmızı Red	■	Stop	Düz Horizontal
	SSB862	Boru For round handrails	Sarı Yellow	Mavi Blue	■	Özürlü Handicapped	Düz Horizontal	
	SSB863	Boru For round handrails	Sarı Yellow	Kırmızı Red	■	Stop	Düz Horizontal	
	SSB867	Boru For round handrails	Sarı Yellow	Mavi Blue	■	Özürlü Handicapped	Yan Vertical	
	SSB868	Düz For flat mount	Sarı Yellow	Mavi Blue	□	Özürlü Handicapped	Düz Horizontal	
	SSB869	Düz For flat mount	Sarı Yellow	Mavi Blue	□	Özürlü Handicapped	Yan Vertical	
	SSB870	Düz For flat mount	Gri Gray	Kırmızı Red	□	Stop	Düz Horizontal	
	SSB871	Düz For flat mount	Sarı Yellow	Kırmızı Red	□	Stop	Düz Horizontal	

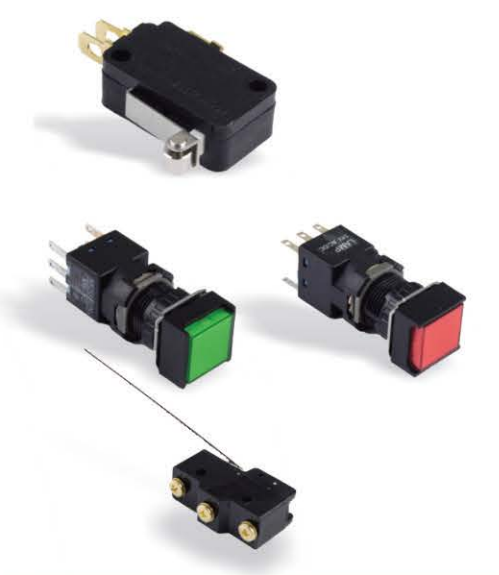

## Switches / Anahtarlar

	Kod Code	Tarif Description
	SW00	Limit Anahtarı Limit Switch
	SW01	Elektrikli Kapı Butonu Yeşil Electrical Door Button (Green)
	SW02	Elektrikli Kapı Butonu Kırmızı Electrical Door Button (Red)
	SW04	Mikro Switch Micro Switch

## Electronic Am / Fm Antenna / Elektronik Am / Fm Anten

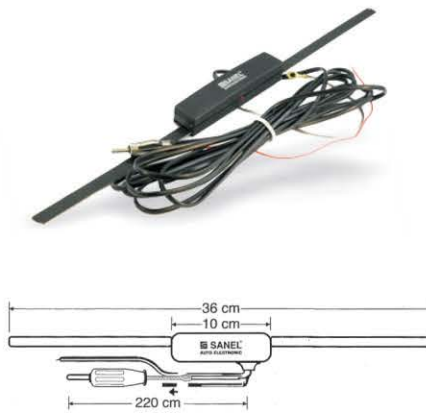
	Kod Code	Volt	Amp.	Ölçüler Dimensions
	SEA412	12V - 24 V	20mA	362(L) x 20(H) x 19(W) mm  Amplifiye edilmiş alıcı çift taraflı yapıştırıcıyla kolay montaj Amplified Receiver, easy mounting with sticker

## Blade Fuse Holder / Ara Bıçak Sigorta Yuvası

	Kod Code	Tarif Description
	SSK003	Kablo: 1mm <sup>2</sup> Uzunluk: 300mm Cable: 1mm <sup>2</sup> Length: 300mm



## Stop Switch / Fren Müşiri

Araç Vehicle	Kod Code	Tarif Description
	Motorcycle SSW100	Normal kapalı Gümüş Kontakt normally closed silver contact

## Regulator / Regülatör

Araçlar Vehicle	Kod Code	V Nom	Çıkış Output
	Mobylette ADZ9	9.0AC	9.0AC

## Commutators / Komütatör

Kod Code	Volt	Açıklama Description	
	BFA935	9V	Sinyalizasyon Signalization
	BFA936	9V	Sinyalizasyon Signalization

## Custom Design / Özel Tasarım

	Müşteri tasarımı parçalar üretilebilmektedir. Motosiklet kumanda gövdesi gibi. We are able to produce custom design parts e.g. clanch, brake, signals, horn.
--	---

# PCB TYPE FUSE & RELAY PANELS / SİGORTA & RÖLE PANOLARI

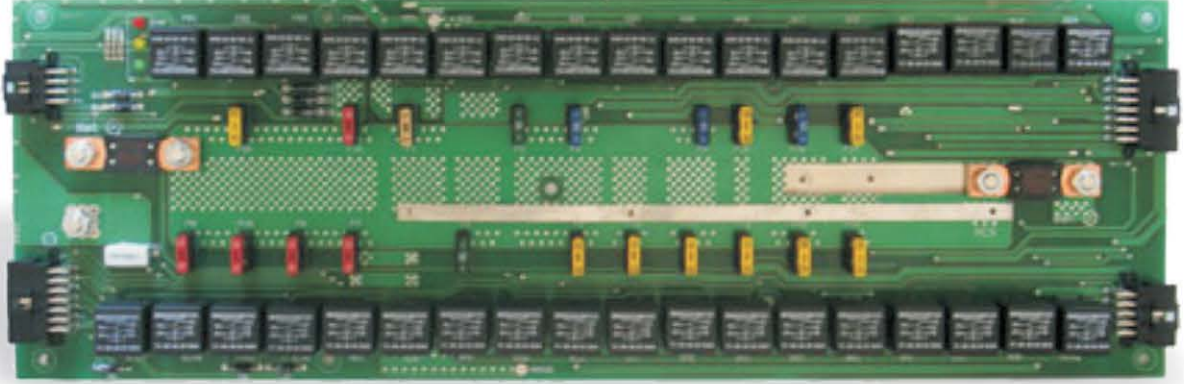

Röle sigorta ve diğer elektronik komponentlerin bir arada bağlanabileceği PCB sistemleri müşterilerimiz için özel olarak dizayn edilmektedir.

**We are able to make custom design PCB Systems for our customers which relays, fuses and other electronic components are connected together.**

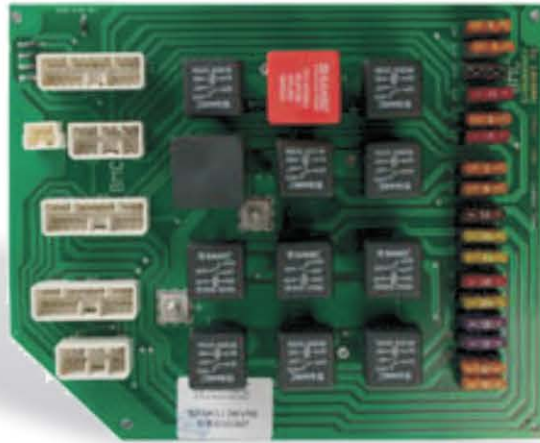



# CABLE HARNESS / KABLO DEMETLEME



Sanel 2004 yılından itibaren kablo tesisatı konusunda yatırıma başlamış olup, konusunda sektör lideri olan Komax, Mecal, Hanke, Schaffner Electrotest firmalarının ekipmanlarını kullanmaktadır. Konusunda deneyimli kadrosuyla % 100 son kontrollü üretim yapmaktadır.

**Sanel has invested on Cable Harness since 2004 and operates sectoral leading machines; Komax, Mecal, Hanke and Schaffner Electrotest equipments under the supervision of well-trained staff with 100% final inspection.**









**emitel**  
meet the expert!

**Test Report**  
**Electromagnetic Compatibility**  
KBA-No.: KBA-P 00057-01

Test report file no: A-03-00321152-00  
Applicant: SANEL SANAYI ELEKTRONIK IMALAT VE TICARET LTD. STI. Cicek Sokak No. 5, Gülsuyu, Maltepe 81560 ISTANBUL, TURKEY

Model: SMC19  
Kind of Product: DC to DC Switch Mode Converter

Manufacturer: SANEL SANAYI ELEKTRONIK IMALAT VE TICARET LTD. STI. Cicek Sokak No. 5, Gülsuyu, Maltepe 81560 ISTANBUL, TURKEY

Test result Emission tests: Positive  
Date of issue: June 25, 2013

**emitel**  
meet the expert!

Test report file no: A-03-00321154-00  
Applicant: SANEL SANAYI ELEKTRONIK IMALAT VE TICARET LTD. STI. Cicek Sokak No. 5, Gülsuyu, Maltepe 81560 ISTANBUL, TURKEY

Model: SFA2618  
Kind of Product: Fluorescent Fixings

Manufacturer: SANEL SANAYI ELEKTRONIK IMALAT VE TICARET LTD. STI. Cicek Sokak No. 5, Gülsuyu, Maltepe 81560 ISTANBUL, TURKEY

**Kraftfahrt-Bundesamt**  
D-24832 Flensburg

**EWG-TYPGENEHMIGUNGSBOGEN**  
EEC TYPE-APPROVAL CERTIFICATE

Benachrichtigung über  
- die Typgenehmigung  
für ein Bauteil gemäß der Richtlinie 72/245/EWG, zuletzt geändert durch die Richtlinie 95/54/EG  
Communication concerning the  
- type-approval  
of a type of component with regard to Directive 72/245/EEC, as last amended by Directive 95/54/EC

Typgenehmigungsnummer: e172245\*95/54\*3781\*00  
Type-approval No.: e172245\*95/54\*3781\*00

Grund für die Erweiterung:  
Reason for extension:  
entfällt  
not applicable

